

Features

- Vitreous China.
- Comfort Height® Elongated Bowl.
- Revolution 360™ swirl flushing system powered by AquaPiston®.
- Includes left-hand polished chrome trip lever.
- 1.28 gpf (4.8 lpf).
- 2-1/8" (54 mm) fully glazed skirted trapway.
- Patented ReadyLock™ installation system.
- 12" (305 mm) rough-in.
- CleanCoat® surface coating.
- Less seat and supply.
- 9-3/4" (248 mm) x 7-1/4" (184 mm) water area.
- 29 1/2" (749 mm) x 16-1/2" (419 mm) x 31-3/8" (797 mm).
- Floor mount / Floor outlet.

Recommended Accessories

- K-4008 Reveal® Quiet-Close™ Elongated Toilet Seat
- K-4108 C3®-230 Elongated Cleansing Toilet Seat
- K-7637 Angle Supply with Stop (single)
- K-5383 10" Rough-in Full Skirt Trap and Attachment System
- K-5381 14" Rough-in Full Skirt Trap and Attachment System
- K-20120-L Trip Lever

Components

Product includes:

- K-4143 Toilet Tank
- K-4144 Elongated Toilet Bowl
- Additional included component/s: Tank Cover, Trip Lever, and ReadyLock™ installation system.



ADA CSA B651 OBC

Codes/Standards







ASME A112.19.2/CSA B45.1
DOE - Energy Policy Act 1992
EPA WaterSense®
California Energy Commission (CEC)
ADA
ICC/ANSI A117.1
CSA B651
OBC

KOHLER® One-Year Limited Warranty

See website for detailed warranty information.

Available Color/Finishes

Color tiles intended for reference only.

Color	Code	Description
	0	White
	96	Biscuit
	NY	Dune
	95	Ice™ Grey
	G9	Sandbar
	7	Black Black™

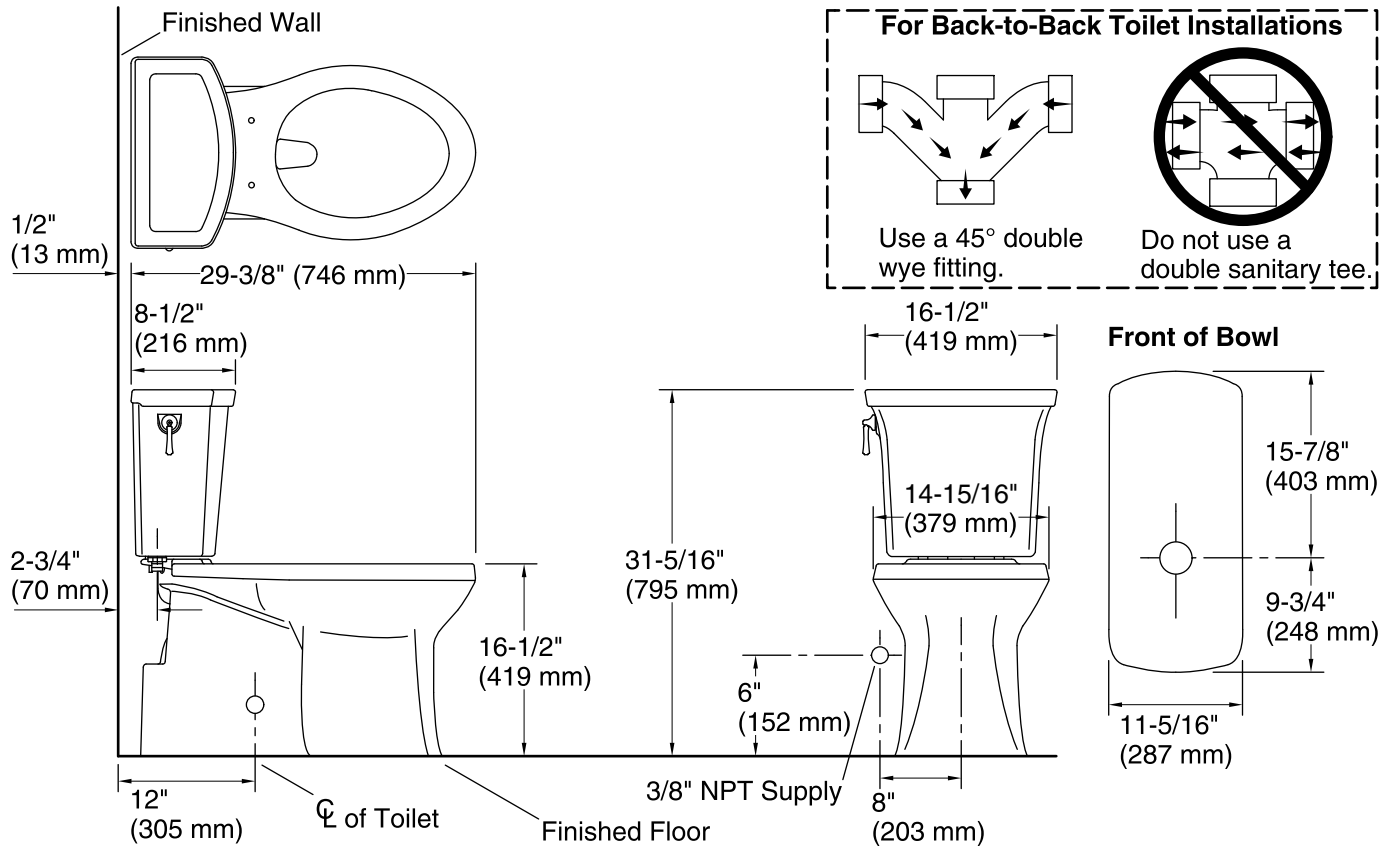

Technical Information

All product dimensions are nominal.

Toilet type:	Two-piece, Floor-mount
Waste Outlet:	Floor
Bowl shape:	Elongated front
Flush type:	Gravity siphon jet
Trap passageway:	2-1/8" (54 mm)
Water Consumption	
Full:	1.28 gpf (4.8 lpf)
Water surface size:	9-3/4" x 7-1/4" (248 mm x 184 mm)
Rim to water surface:	6-1/4" (159 mm)

Fixture Supply Requirements

Min static pressure:	15 psi (103.4 kPa)
Max static pressure:	80 psi (551.6 kPa)

Notes

Install this product according to the installation instructions.

For back-to-back toilet installations: Use only a 45° double wye fitting.

ADA, OBC, CSA B651 compliant when installed to the specific requirements of these regulations.

Plumbing Codes require elongated toilets and elongated, open-front toilet seats in public bathrooms.

Accessibility standards require controls to be located on the open side of the toilet.