

EVIVA

installation guide
for EVVN666-84 /96

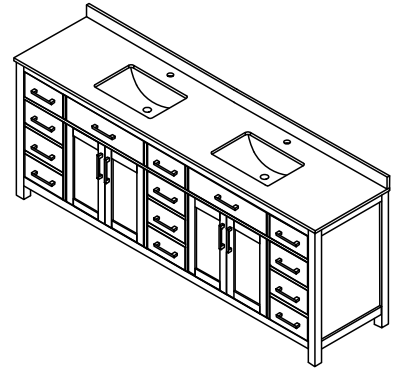
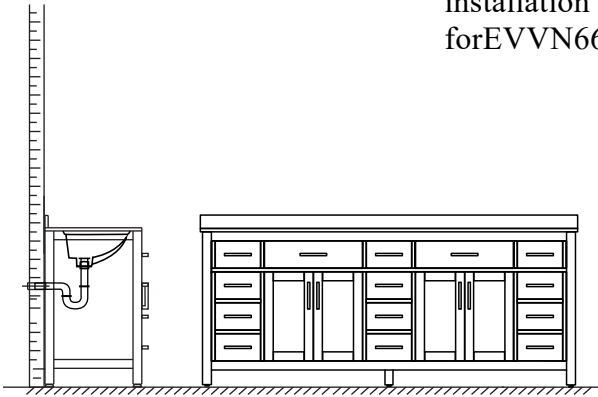

PACKING LIST

(Not all components may be included, depending upon your purchase)

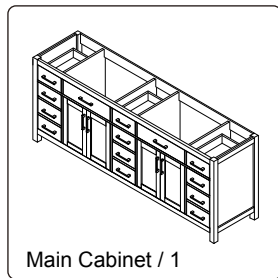
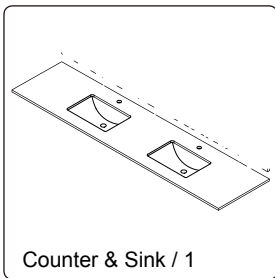

HOW TO ADJUST HINGES (if required)

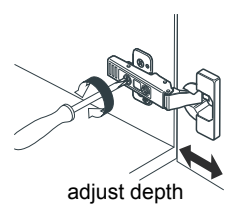
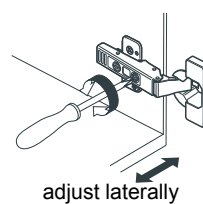
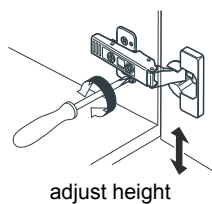
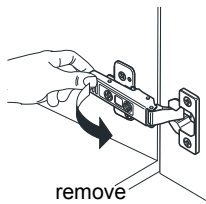
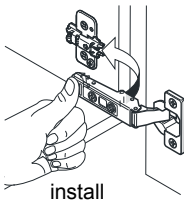

REQUIRED TOOLS NOT IN BOX



Silicone sealant

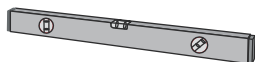

Spirit Level

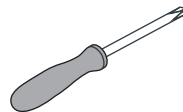

Phillips Screwdriver

INSTALLATION INSTRUCTIONS

