



## Grip-Tight Cachet® Q3™

Toilet Seat  
K-4639

### Features

- Solid polypropylene plastic.
- Round closed-front.
- Contoured seat for user comfort.
- Quiet-Close™ lid and ring prevents slamming.
- Quick-Release™ hinge caps snap open and seat pulls forward for removal.
- Quick-Attach™ stainless steel fastener allows for top-mount screwdriver only install.
- Grip-tight bumpers hold seat firmly in place.



### Codes/Standards











IAPMO/ANSI Z124.5

### KOHLER® One-Year Limited Warranty

See website for detailed warranty information.

### Available Color/Finishes

*Color tiles intended for reference only.*

Color	Code	Description
	0	White
	96	Biscuit
	47	Almond
	NY	Dune
	95	Ice™ Grey
	G9	Sandbar
	33	Mexican Sand™
	K4	Cashmere
	58	Thunder™ Grey
	7	Black Black™

USA/Canada: 1-800-4KOHLER (1-800-456-4537)

Kohler Co. reserves the right to make revisions without notice to product specifications.

For the most current Specification Sheet, go to [www.kohler.com](http://www.kohler.com).

9-5-2016 03:30

THE BOLD LOOK  
OF **KOHLER**®

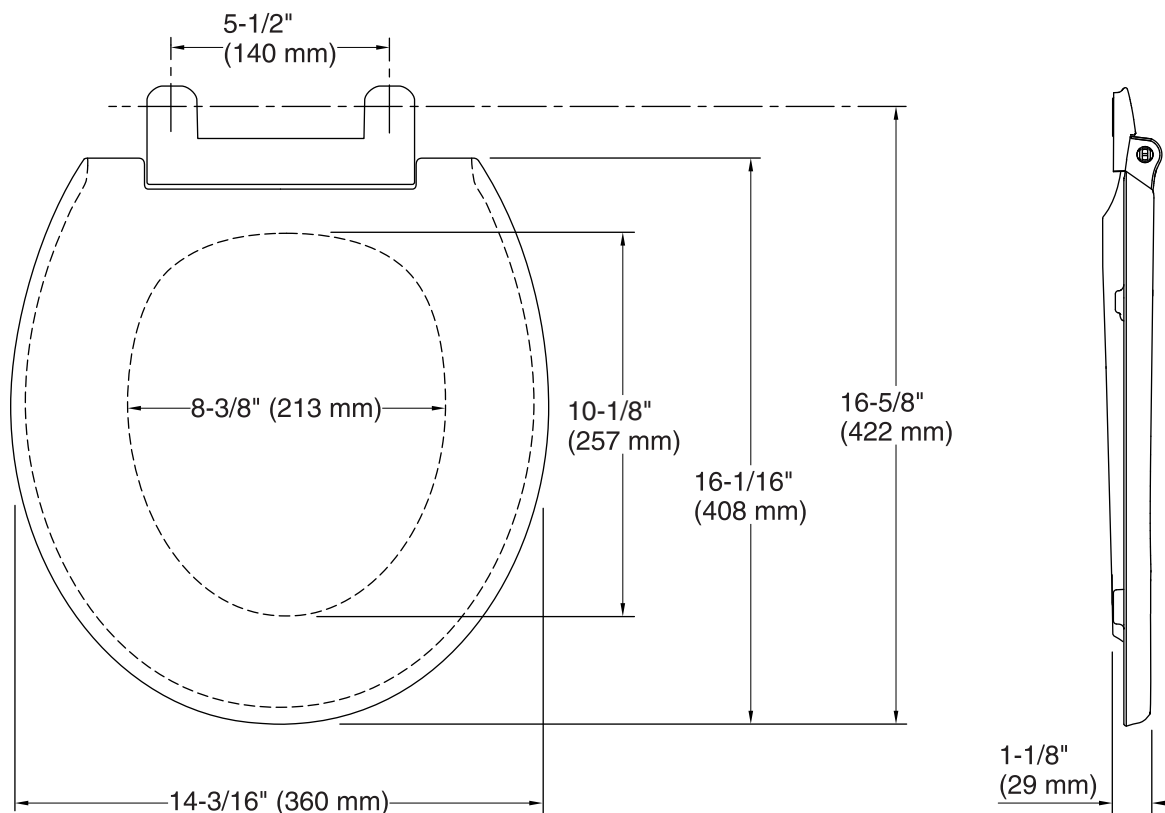

### Technical Information

All product dimensions are nominal.

Seat shape type: Round

Seat front type: Closed front

Seat hinge type: Quick-Attach®, Quick-Release™, Quiet-Close™

Seat-mounting holes: 5-1/2" (140 mm)

### Notes

Install this product according to the installation guide.