

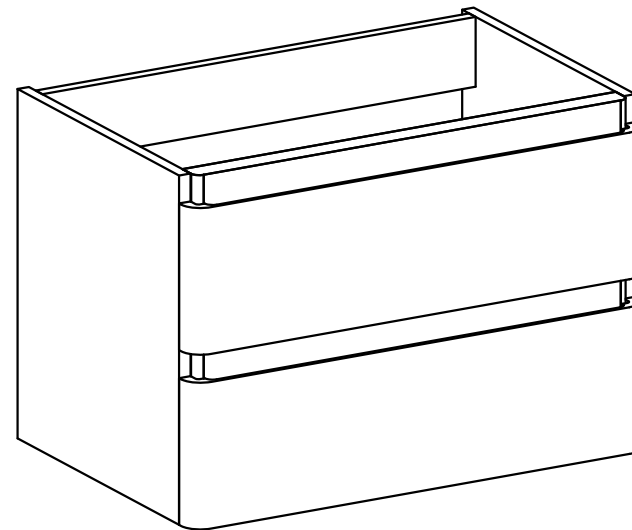

1A070043. MD

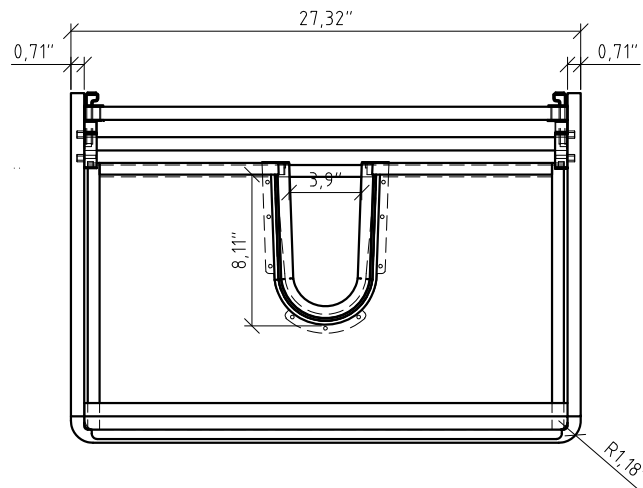
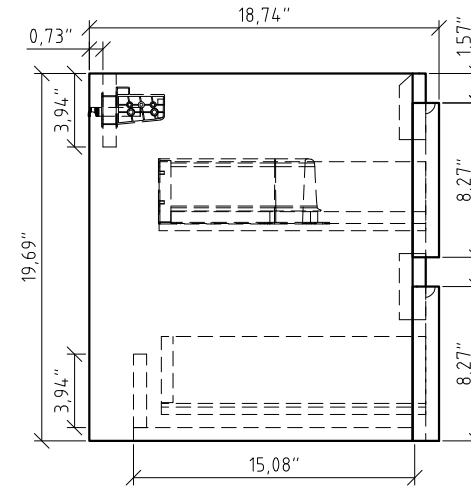
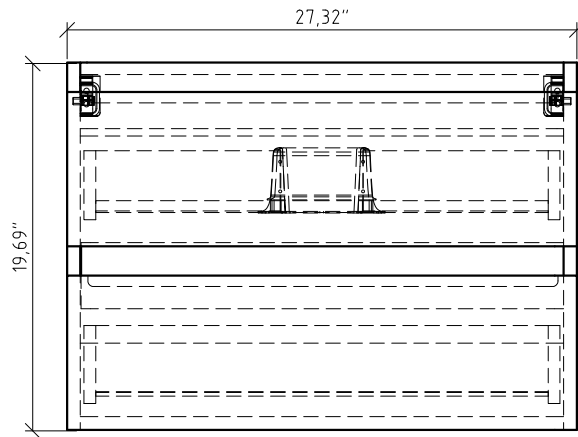

Designer: XJ
2017.08.14