



Features

- Slotted overflow for deep soaking.
- End drain.
- Integral lumbar support.
- Coordinates with other products in the Archer® collection.
- 60" (1524 mm) x 30" (762 mm) x 19" (483 mm)

Material

- Acrylic

Hydrotherapy

- Single-speed whirlpool offers eight fully adjustable hydro-massage jets for water flow and direction.
- Pump with air switch for whirlpool.

Installation

- Drop-in

Required Accessories

K-7271 Brass Slotted Overflow Bath Drain

or

K-7272 PVC Slotted Overflow Bath Drain

Recommended Accessories

K-24916 Wireless Music Kit



ADA

Codes/Standards

ASME A112.19.7/CSA B45.10

CSA B45.5/IAPMO Z124

UL 1795

CSA C22.2 No. 218.2

Greenguard UL 2818 - Gold

ADA

ICC/ANSI A117.1

KOHLER® Plastic Baths and Receptors

Lifetime Limited Warranty

KOHLER® Hydrotherapy Components







Five-Year Limited Warranty

See website for detailed warranty information.

Available Color/Finishes

Color tiles intended for reference only.

Color Code Description

	0	White
	96	Biscuit
	47	Almond
	NY	Dune
	95	Ice™ Grey
	G9	Sandbar
	K4	Cashmere

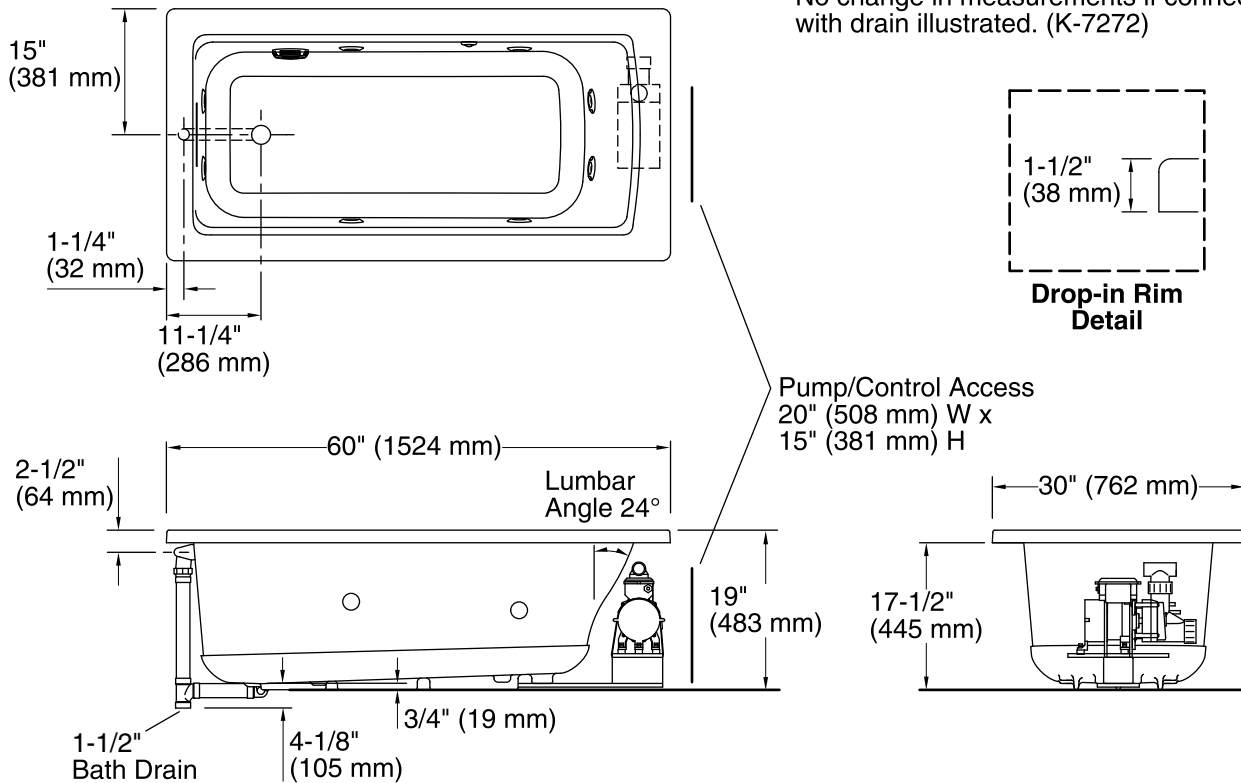

No change in measurements if connected with drain illustrated. (K-7272)

Required Electrical Service

One dedicated circuit required, protected with Class A Ground-Fault Circuit-Interrupter (GFCI) or Residual Current Device (RCD).

Pump: 120 V, 15 A, 60 Hz

Technical Information

All product dimensions are nominal.

Installation: Drop-in
 Drain location: End
 Basin area, bottom: 45-1/8" x 19-11/16" (1146 mm x 500 mm)
 Basin area, top: 52-1/8" x 22-1/16" (1324 mm x 560 mm)
 Weight: 98 lbs (44.5 kg)
 Minimum floor load: 48 lbs/ft² (234.4 kg/m²)
 Water depth: 15-1/8" (384 mm)
 Water capacity: 57 gal (215.8 L)
 Cutout: Drop-in, 58-1/2" x 28-1/2" (1486 mm x 724 mm)
 Electrical component rating: Pump: 120 V, 7 A, 60 Hz
 Pump speed: Single
 Minimum flat for door: 2" (51 mm)

Notes

Measure your actual product for rough-in details. Install this product according to the installation instructions.
 The hot water supply should be 70% of the capacity of the bath or greater. Installations will vary.
 ADA compliant when installed to the specific requirements of these regulations.