



Iron/Tones®

Top-mount or Under-mount Kitchen Sink
K-6587

Features

- 21-inch minimum base cabinet width (top-mount applications).
- 24-inch minimum base cabinet width (under-mount applications).
- KOHLER cast iron.
- Acid-resistant enamel finish.
- Single bowl.
- Top-mount or under-mount.
- 20-7/8" (530 mm) x 20-7/8" (530 mm) (top-mount)

Optional Accessories

K-8801 Sink Strainer

Components

Product includes:

52047 Clamp Accessory Pack, 4 Ea.



Codes/Standards

ASME A112.19.1/CSA B45.2

KOHLER® Enameled Cast Iron Kitchen Sink - Lifetime Limited Warranty

See website for detailed warranty information.

Available Color/Finishes

Color tiles intended for reference only.

Color	Code	Description
	0	White
	FF	Sea Salt™
	96	Biscuit
	47	Almond
	FD	Cane Sugar™
	NY	Dune
	95	Ice™ Grey
	G9	Sandbar
	33	Mexican Sand™
	K4	Cashmere
	FT	Basalt
	58	Thunder™ Grey
	20	Suede
	KA	Black 'n Tan
	FP	Caviar
	7	Black Black™

USA/Canada: 1-800-4KOHLER (1-800-456-4537)

Kohler Co. reserves the right to make revisions without notice to product specifications.

For the most current Specification Sheet, go to www.kohler.com.

7-4-2015 06:49



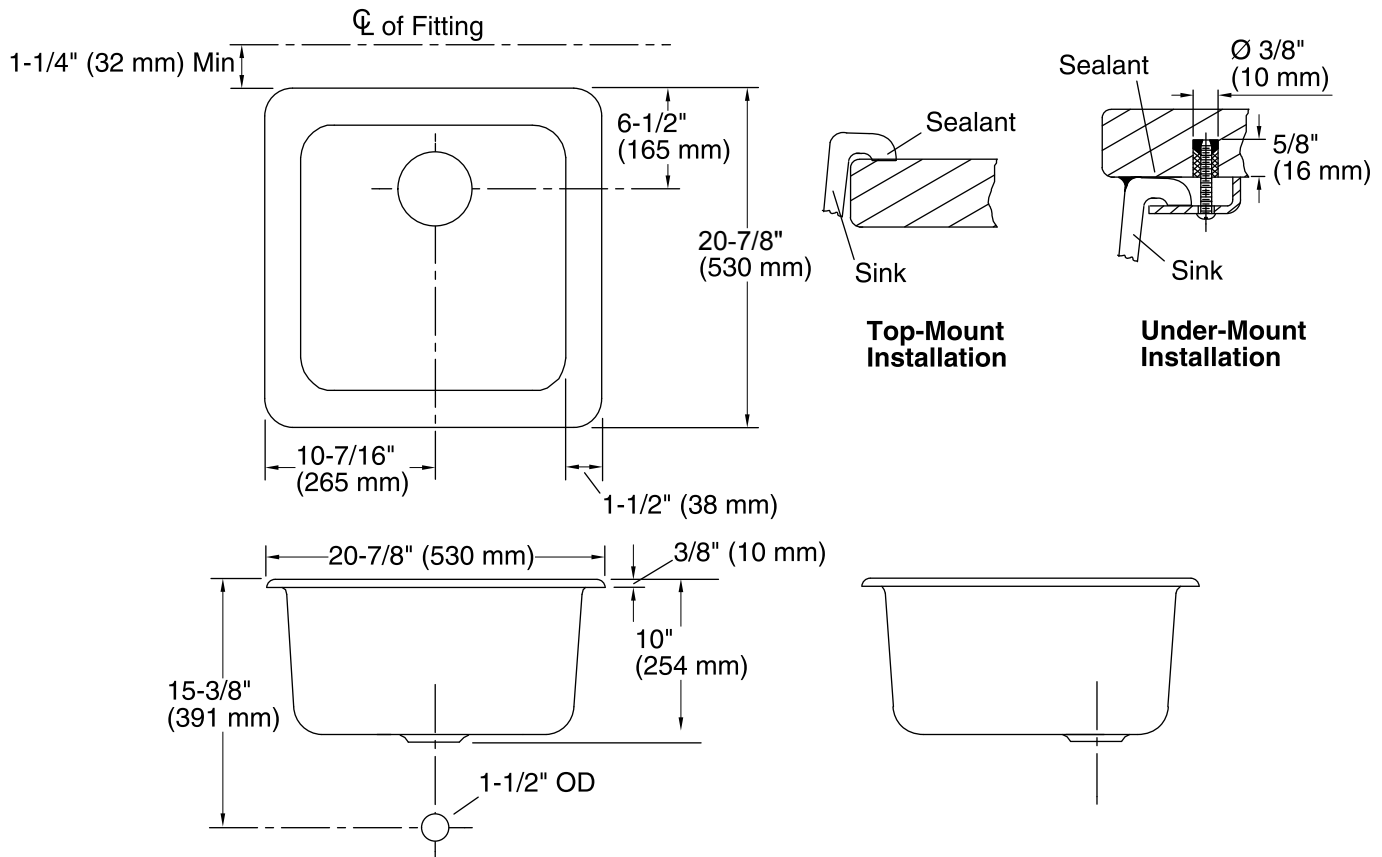

Technical Information

All product dimensions are nominal.

Bowl configuration:	Single
Installation:	Top-mount, Under-mount
Bowl area	Length: 18" (457 mm) Width: 18" (457 mm) Bowl depth: 9-1/2" (241 mm)
Drain hole:	3-7/8" (98 mm)
Template:	Top-mount/Under-mount, 114335-7, required, included

Notes

Install this product according to the installation guide.

Supplied bowl clamp assemblies require 1" (25 mm) minimum countertop thickness. Installer must supply hardware for thinner countertops.

For multiple bowl under-mount installations, a minimum distance of 3-3/8" (86 mm) is required between bowls. Countertop supplier to determine required support.