

KOHLER® Faucets 14" rainhead with Katalyst® air-induction technology, 2.5 gpm K-13691

Features

- Single-function rain showerhead.
- MasterClean™ sprayface features an easy-to-clean surface that withstands mineral buildup.
- Katalyst® spray technology with air-induction ball joint.
- Optimized sprayface for maximum performance.
- 2.5 gpm (9.5 lpm) maximum flow rate.
- 1/2" - 14 NPT connection.

Material

- Solid brass construction for durability and reliability.

Recommended Products/Accessories

K-23723 Faucet cleaner



Codes/Standards







ASME A112.18.1/CSA B125.1
DOE - Energy Policy Act 1992

KOHLER® Faucet Lifetime Limited Warranty

See website for detailed warranty information.

Available Colors/Finishes

Color tiles intended for reference only.

Color	Code	Description
	CP	Polished Chrome
	SN	Vibrant® Polished Nickel
	PGD	Vibrant® Moderne Polished Gold
	BN	Vibrant® Brushed Nickel
	BV	Vibrant® Brushed Bronze
	2MB	Vibrant® Brushed Moderne Brass
	TT	Vibrant Titanium

1-800-4KOHLER (1-800-456-4537)

Kohler Co. reserves the right to make revisions without notice to product specifications.

For the most current Specification Sheet, go to www.kohler.com.

12-6-2020 17:08 - US/CA/MX

THE BOLD LOOK
OF **KOHLER**®

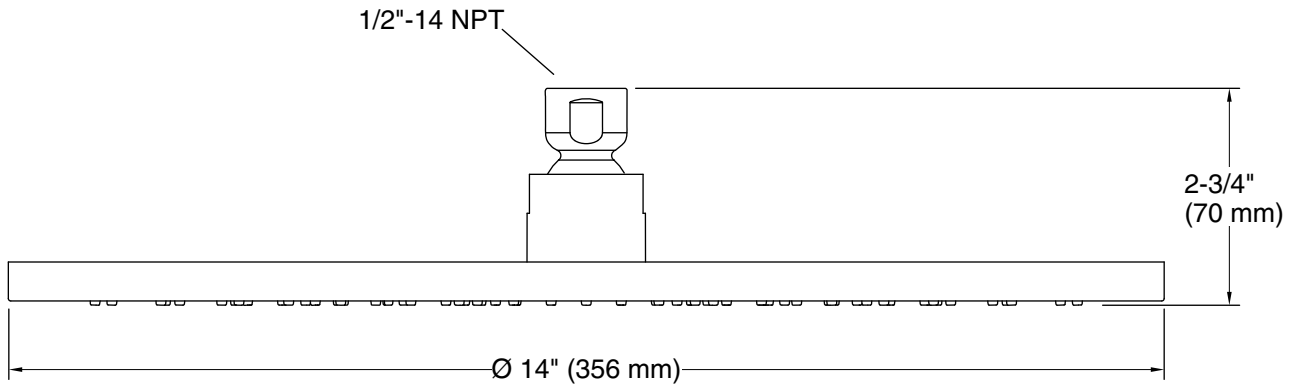

Technical Information

All product dimensions are nominal.

Faucet:

Flow rate: 2.5 gal/min (9.5 l/min)

Notes

Install this product according to the installation instructions.