



### Features

- Right drain.
- Low-threshold assures ease of exit and entry of the shower space.
- Water containment bead along the step over threshold provides optimum barrier to eliminate water escaping from the shower.
- Textured bottom surface.
- One-piece construction.
- Compliments traditional and contemporary bathroom designs.
- Coordinates with Choreograph™ walls.

### Material

- Acrylic

### Installation

- Alcove
- 3-side integral flange.



### Codes/Standards







CSA B45.5/IAPMO Z124  
ASTM E162  
ASTM E662  
Greenguard UL 2818 - Gold

### KOHLER® One-Year Limited Warranty

See website for detailed warranty information.

### Available Color/Finishes

*Color tiles intended for reference only.*

Color	Code	Description
	0	White
	96	Biscuit
	47	Almond
	NY	Dune
	95	Ice™ Grey
	G9	Sandbar

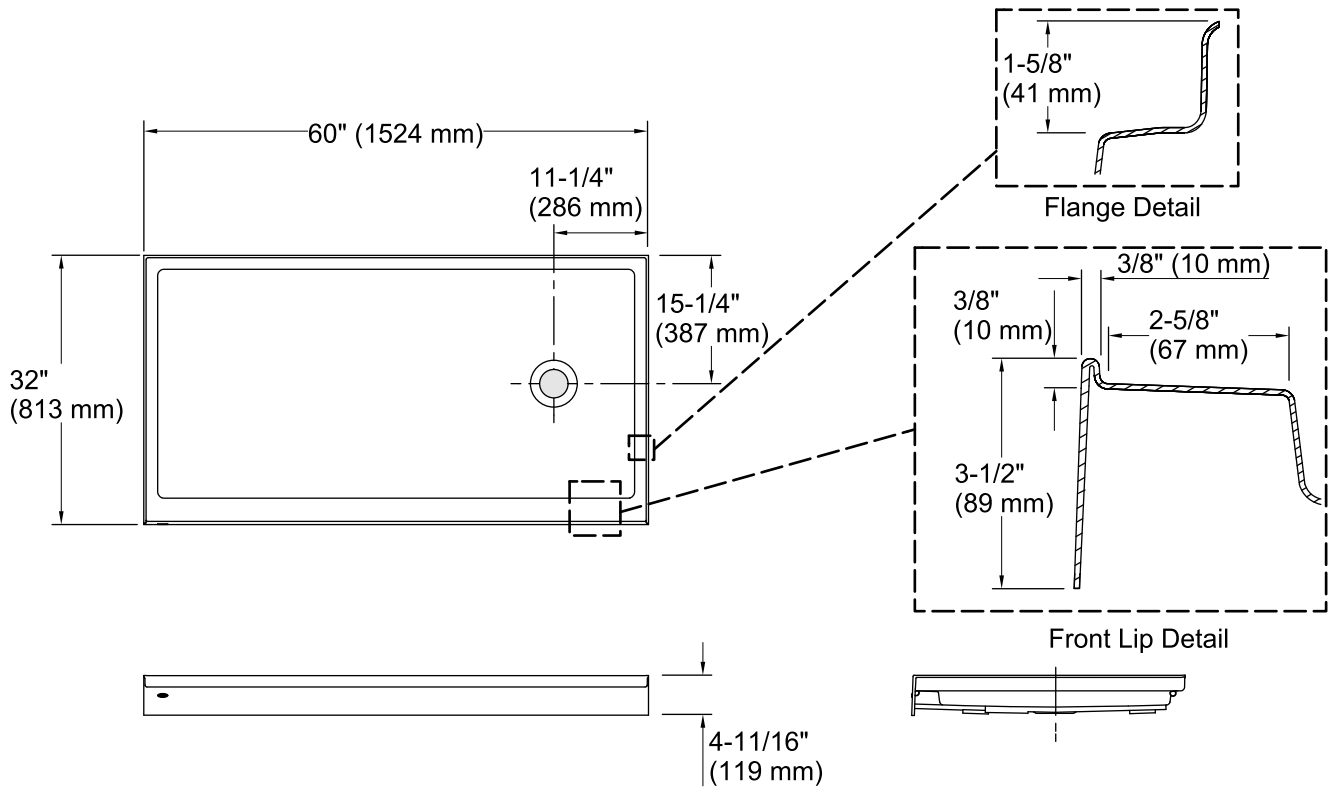

## Technical Information

All product dimensions are nominal.

Installation:	3-Wall Alcove
Drain location:	Right
Weight:	62 lbs (28.1 kg)
Minimum flat for door:	2-5/8" (67 mm)
Threshold height:	3-1/2" (88 mm)

## Notes

Measure your actual product for rough-in details.

Install this product according to the installation instructions.

Subfloor must be within 1/2" (13 mm) of level.

This receptor has a front lip. This should be taken into account when installing a shower door.