

# Wall Fixings

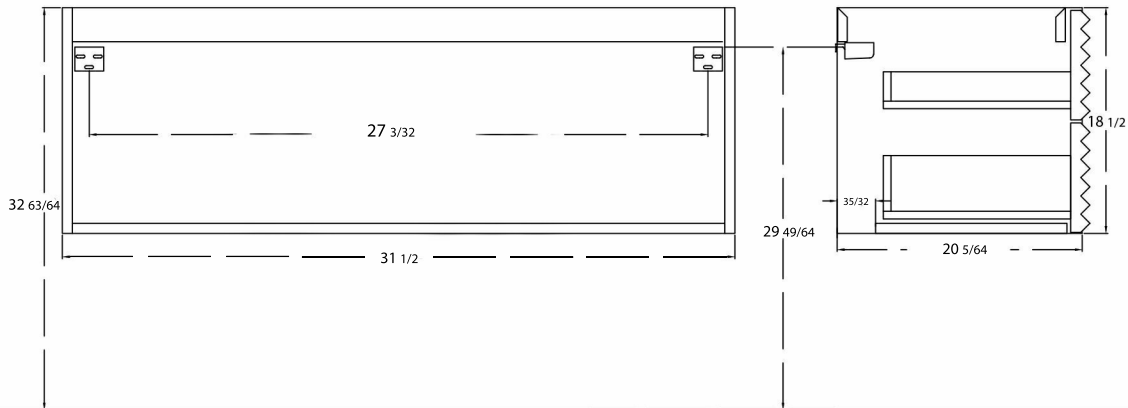

Tolerance  $\pm \frac{5}{64}$

SERIES

BATZ

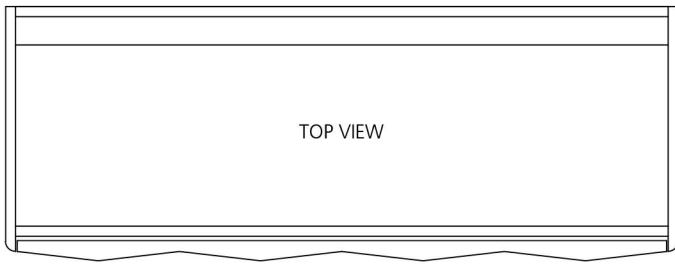
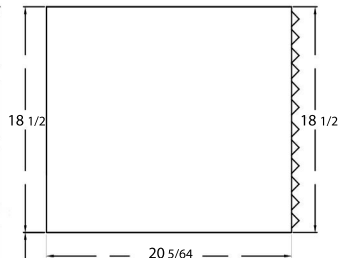
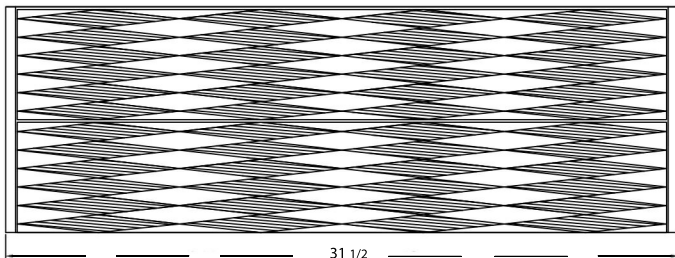

$32 \frac{63}{64}$

$14 \frac{31}{64}$

Tolerance  $\pm \frac{5}{64}$

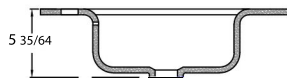
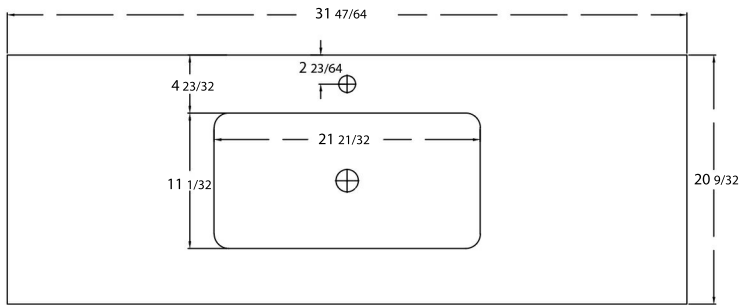
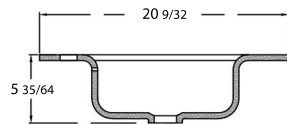
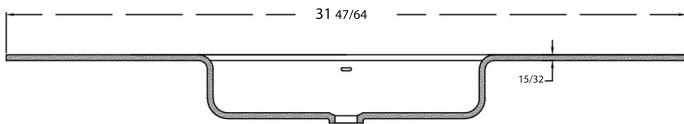

Tolerance  $\pm 5/64$